

GAMMA DIMENSIONALE - LAMIERE DA TRENO

PESO TEORICO DEL FOGLIO

SPESSORE mm	PESO Kg/mq	DIMENSIONI IN MILLIMETRI - PESO IN Kg-PESO SPECIFICO 7,85 Kg/m ²						
		6000 x 2000	6000 x 2500	8000 x 2000	8000 x 2500	10000 x 2500	12000 x 2500	12000 x 3000
		12 mq	15 mq	16 mq	20 mq	25 mq	30 mq	36 mq
5	39,25	471	589	628	785	982	1178	1413
6	47,1	566	707	754	942	1178	1413	1696
7	54,95	660	825	880	1099	1374	1649	1978
8	62,8	754	942	1005	1256	1570	1884	2261
9	70,65	848	1060	1131	1413	1767	2120	2544
10	78,5	942	1178	1256	1570	1963	2355	2826
11	86,35	1037	1296	1382	1727	2159	2591	3109
12	94,2	1131	1413	1508	1884	2355	2825	3392
13	102,05	1225	1531	1633	2041	2552	3062	3674
14	109,9	1319	1649	1759	2198	2748	3297	3957
15	117,75	1413	1767	1884	2355	2944	3533	4239
16	125,6	1508	1884	2010	2512	3140	3768	4522
18	141,3	1696	2120	2261	2826	3533	4239	5087
20	157	1884	2355	2512	3140	3925	4710	5652
22	172,7	2073	2591	2764	3454	4318	5181	6218
25	196,25	2355	2944	3140	3925	4907	5888	7065
26	204,1	2450	3062	3266	4082	5103	6123	7348
28	219,8	2638	3297	3517	4396	5495	6594	7913
30	235,5	2826	3533	3768	4710	5888	7065	8478
35	274,75	3297	4122	4396	5495	6869	8243	9891
40	314	3768	4710	5024	6280	7850	9420	11304
45	353,25	4239	5299	5652	7065	8832	10598	12717
50	392,5	4710	5888	6280	7850	9813	11775	14130
55	431,75	5181	6477	6908	8635	10794	12953	15543
60	471	5652	7065	7536	9420	11775	14130	16956
65	510,25	6123	7654	8164	10205	12757	15308	18396
70	549,5	6594	8243	8792	10990	13738	16485	19782
75	598,75	7065	8832	9420	11775	14719	17663	21555
80	628	7536	9420	10048	12560	15700	18840	22608
85	667,25	8007	10009	10676	13345	16682	20018	24021
90	706,5	8478	10598	11304	14130	17663	21195	25434
95	745,75	8949	11187	11923	14915	18644	22373	26847
100	785	9420	11775	12560	15700	19625	23550	28260
110	863,5	10362	12953	13816	17270	21588	25905	-
120	942	11304	14130	15072	18840	23550	28260	-
125	981,25	11775	14719	15700	19625	24532	29438	-
130	1020,5	12246	15308	16328	20410	25513	30615	-
140	1099	13188	16485	17584	21980	27475	-	-
150	1177,5	14130	17663	18840	23550	29438	-	-

LAMIERE NERE

A CALDO S235 JR + UNI EN 10025

UNI EN 10143

spessore mm	peso kg/m ²	1000 x 2000	1250 x 2500	1500 x 3000	1500 x 6000	1800 x 6000	2000 x 6000
		peso in kg					
1.5	11.8	23.6	36.7	53			
1.8	14.1	28.2	44.2	64			
2	15.7	31.4	49	71			
2.5	19.6	39.3	61	88	176.4		
3	23.6	47.1	73	106	212.4	254.8	280
3.5	27.5	55	85.9	123.6	247.3		329.7
4	31.4	62.8	98	141	282.6	339.12	376.8
5	39.2	78.5	123	176	352.8	423.3	472
6	47.1	94.2	147	212	423.9	508.6	566
7	55	110	172	247	495	594	660
8	62.8	126	196	282	565.2	678.2	754
9	70.6	141	221	318	635.4	762.4	848
10	78.5	157	245	353	706.5	847.8	942
12	94.2	188	294	424			1131
15	117.8	236	368	530			1416

LAMIERE

PANNELLI

RETI
ELETTRO-
SALDATE

LAMIERE
FORATE E
STIRATE

TUBOLARI

PROFILI
APERTI

TUBI
SENZA
SALDATURA

GRIGLIATI

NORME
TECNICHE

CONDIZIONI
GENERALI
DI VENDITA

LAMIERE LUCIDE

UNI EN 10130

spessore mm	peso kg/m ²	1000 x 2000	1250 x 2500	1500 x 3000
		peso in kg		
0.3	2.36	4.72		
0.35	2.75	5.51		
0.4	3.14	6.28		
0.45	3.53	7.06		
0.5	3.93	7.86		
0.6	4.71	9.42	14.7	
0.8	6.28	12.6	19.7	28.3
1	7.85	15.7	24.5	35
1.2	9.42	18.8	29.5	42
1.5	11.8	23.6	36.7	53
1.8	14.1	28.2	44.2	64
2	15.7	31.4	49	71
2.5	19.6	39.3	61	88
3	23.6	47.1	73	106

LAMIERE DECAPATA

UNI EN 10111

spessore mm	peso kg/m ²	1000 x 2000	1250 x 2500	1500 x 3000
		peso in kg		
1.5	11.8	23.6	36.7	53
1.8	14.1	28.2	44.2	64
2	15.7	31.4	49	71
2.5	19.6	39.3	61	88
3	23.6	47.1	73	106
3.5	27.5	55	85.9	123.6
4	31.4	62.8	98	141
5	39.2	78.5	123	176
6	47.1	94.2	147	212
7	55	110	172	247
8	62.8	126	196	282
9	70.6	141	221	318
10	78.5	157	245	353
12	94.2	188	294	424
15	117.8	236	368	530

LAMIERE ZINCATE

UNI EN 10346

spessore mm	peso kg/m ²	1000 x 2000	1250 x 2500	1500 x 3000
		peso in kg		
0.3	2.36	4.72		
0.35	2.75	5.51		
0.4	3.14	6.28		
0.45	3.53	7.06		
0.5	3.93	7.86		
0.6	4.71	9.42	14.7	21.19
0.8	6.28	12.6	19.7	28.3
1	7.85	15.7	24.5	35
1.2	9.42	18.8	29.5	42
1.5	11.8	23.6	36.7	53
1.8	14.1	28.2	44.2	64
2	15.7	31.4	49	71
2.5	19.6	39.3	61	88
3	23.6	47.1	73	106
3.5	27.5	55	85.9	123.6
4	31.4	62.8	98	141
5	39.2	78.5	123	176

LAMIERE STRIATE

UNI 3151

h = altezza striatura
 Per spessori < 3 mm : 1,00 < h < 2,00 mm
 Per spessori ≥ 3 mm : h secondo norma
 Superficie in rilievo : ≥ 30 %

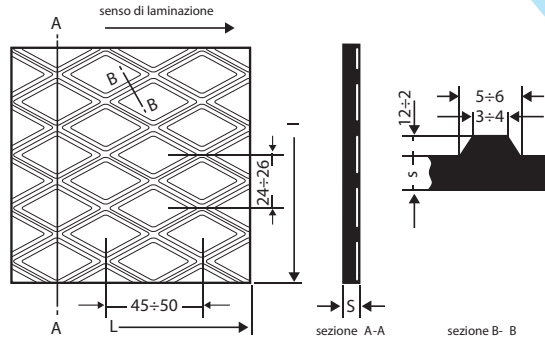

spessore mm	peso kg/m ²	dimensioni in mm				
		1000 x 2000	1000 x 3000	1250 x 2500	1500 x 3000	1500 x 6000
		peso in kg				
* 2.5	22.2	45		69	100	
3	28.6	57.2	85.8	89.4	128.7	257.4
4	36.5	73	109.5	114	164.3	328.5
5	44.3	88.6	132.9	138.5	199.4	398.7
6	52.1	104.2	156.3	163	234.5	486.9
8	67.8	135.6	203.4	211.9	305.1	610.2
10	83.6	167.2	250.8	261.2	376.2	752.4
12	99.1	198.2	297.3	309.7	446	891.9

* non unificato

LAMIERE BUGNATE

UNI 4630

h = altezza bugna
 Per spessori < 3 mm : 1,00 < h < 2,00 mm
 Per spessori ≥ 3 mm : h secondo norma
 Superficie in rilievo : ≥ 30 %

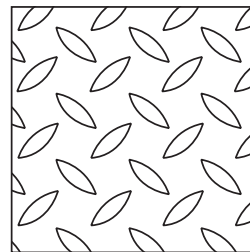

spessore mm	peso kg/m ²	dimensioni in mm		
		1000 x 2000	2500 x 1250	3000 x 1500
		peso in kg		
3	26.05	52.1	81.1	117
4	33.95	67.9	106	153
5	41.75	83.5	130.1	187.6
6	49.60	99.2	154	223
8	65.30	130.6	204	284
10	81.10	162.2	250	365

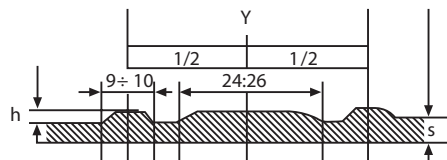

LAMIERE

PANNELLI

RETI
ELETTO-
SALDATE

LAMIERE
FORATE E
STIRATE

TUBOLARI

PROFILI
APERTI

TUBI
SENZA
SALDATURA

GRIGLIATI

NORME
TECNICHE

CONDIZIONI
GENERALI
DI VENDITA

LAMIERE GRECATE PER SOLAI UNI EN 1993-1-3 EGB 210

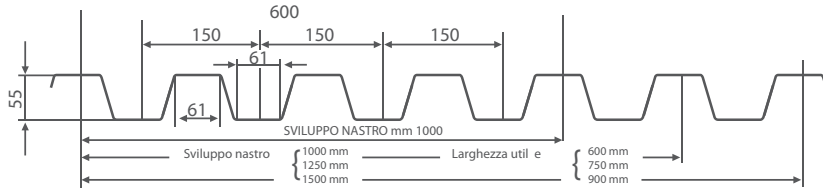

**lung.
6000**

caratteristiche statiche							
spessore mm		0.6	0.7	0.8	1.0	1.2	1.5
peso kg/m²		7.85	9.15	10.46	13.08	15.70	19.62
peso kg/m lineare	1000	4.71	5.49	6.28	7.85	9.42	11.77
	1250	5.88	6.86	7.85	9.81	11.77	14.17
	1500	7.06	8.24	9.42	11.77	14.13	17.66
J cm⁴/m		41.76	51.16	59.89	78.23	96.83	122.74
W cm³/m		14.37	18.06	21.59	27.66	33.31	41.31

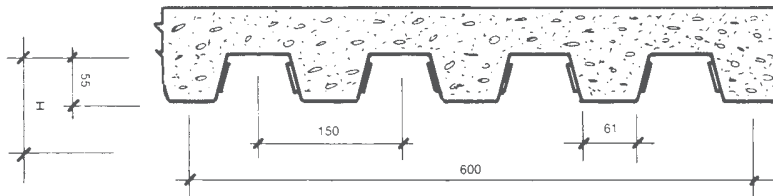

EGB 210/D

**con soletta
collaborante**

caratteristiche statiche					
spessore m m	0.7	0.8	1.0	1.2	1.5
peso kg/m²	9.15	10.46	13.08	15.70	19.62
peso kg/m lineare	5.49	6.28	7.85	9.42	11.77
J cm⁴/m	50.05	59.15	77.63	96.48	122.52
W cm³/m	15.38	18.52	25.00	31.81	41.22

**lung.
6000**

LAMIERE GRECATE PER COPERTURE PARETI TIPO EGB 401

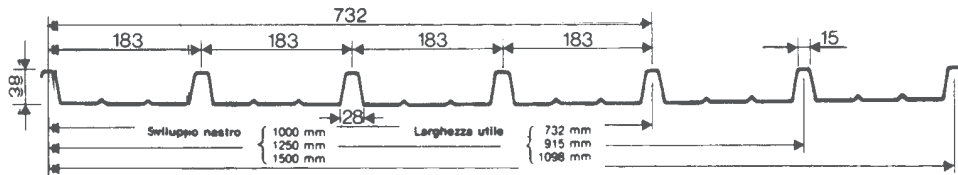

caratteristiche statiche					
spessore mm		0.6	0.7	0.8	1.0
peso kg/m²		6.42	7.49	8.57	10.72
peso kg/m lineare	1000	4.71	5.49	6.28	7.85
	1250	5.88	6.86	7.85	9.81
	1500	7.06	8.24	9.42	11.77
J cm⁴/m		13.79	16.04	18.31	22.83
W cm³/m		4.75	5.55	6.36	7.98

**lung.
2000
3000**

LAMIERE GRECATE PER SOLAI COLLABORANTE TIPO EGB 1200/D

**SOLO SU
RICHIESTA**

CON SOLETTA COLLABORANTE

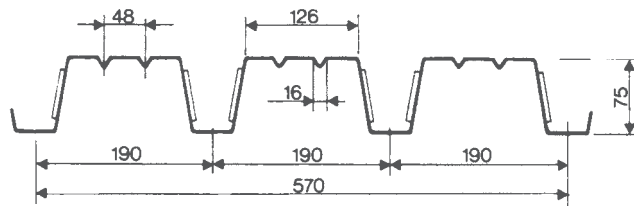

caratteristiche statiche						
spessore m m	0.6	0.7	0.8	1.0	1.2	1.5
peso kg/m ²	8.26	9.64	11.00	13.75	16.50	20.65
peso kg/m lineare	4.71	5.49	6.28	7.85	9.42	11.77
Jx/m r idotto cm ⁴ /m	83.3	100.6	117.30	148.5	179.1	222.30
Wx sup. cm ³ /m	29.5	37.1	44.1	57.5	70.2	87.2
Wx inf. cm ³ /m	17.8	21.0	24.2	30.2	36.2	44.9

LAMIERE

PANNELLI

RETI
ELETTRO-
SALDATE

LAMIERE
FORATE E
STIRATE

LAMIERE ZINCATE ONDULATE

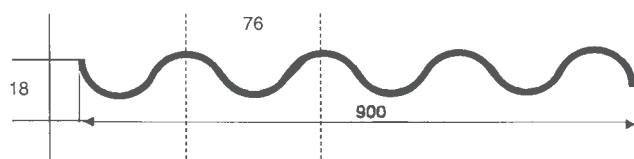

lungh. 2000

spessore m m	0.25	0.30	0.40	0.50	0.60	0.80	1.00
peso kg/m ²	2.14	2.73	3.52	4.30	5.10	6.65	8.25

TUBOLARI

PROFILI
APERTI

TUBI
SENZA
SALDATURA

GRIGLIATI

NORME
TECNICHE

CONDIZIONI
GENERALI
DI VENDITA